

PARTS LIST

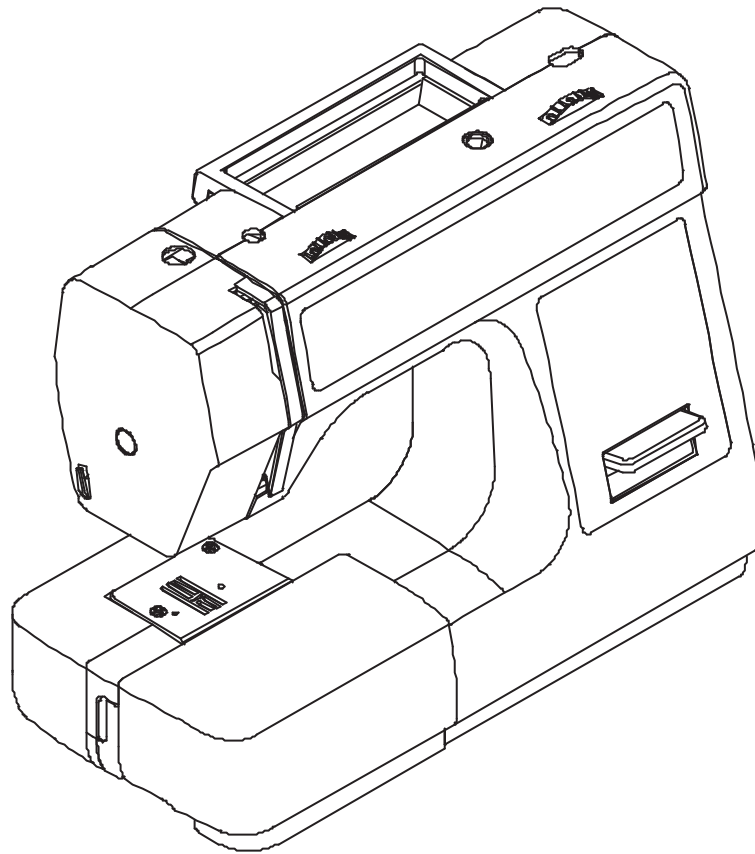

E10

A

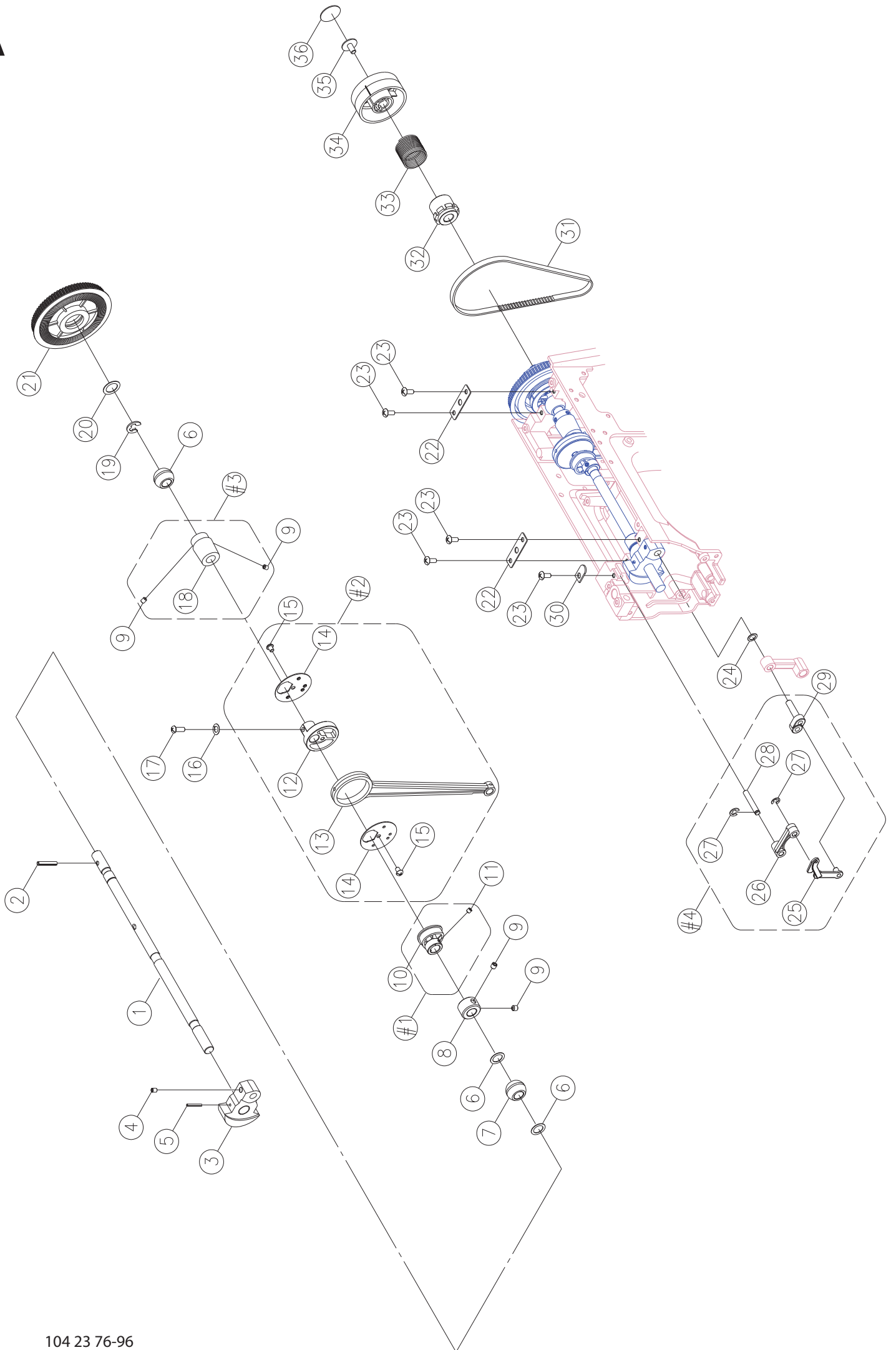

No.	Part No.	Description
1	270 V60033000	ARM SHAFT
2	416117601	SPRING PIN(ϕ 3×18)
3	270 V61473000	ARM SHAFT BALANCE
4	416122101	SET SCREW(M4×6 C)
5	270 003043524	ARM SHAFT BALANCE PIN (ϕ 3.5×24)
6	270 004400080	ENDURE ATTRITION WASHER (10.2×15×0.5)
7	416156301	ARM SHAFT BUSING
8	416524101	ARM SHAFT COLLAR COMPLETE
9	416121001	SET SCREW(M4×5 C)
10	270 G4A0533000	FEED CAM
11	416122401	SET SCREW(M4×4 C)
12	416604601	CRANK CONNECTING ROD CAM
13	416604601	CRANK CONNECTING ROD
14	416604601	CRANK CONNECTING ROD COVER
15	416604601	SET SCREW (M4X4 B)
16	270 004600026	WASHER(4.2×7.2×1.2)
17	270 004107063	SET SCREW(11/64×40×12)
18	416524601	ARM SHAFT WORM
19	416116501	E-RING (ETW-9)
20	416124701	WASHER(10.2×15×0.5)
21	416148501	ARM SHAFT DRIVER BELT PULLEY
22	416161701	ARM SHAFT BUSHING HOLDER PLATE
23	416121501	SET SCREW(M4×8 A)
24	416524701	ENDURE ATTRITION WASHER (6.2×12×0.25)
25	270 E1A2513001	THREAD TAKE UP LEVER
26	416157901	THREAD TAKE UP LEVER SUPPORTER
27	416116101	E-RING (ETW-4)
28	270 V60223003	THREAD TAKE UP LEVER SUPPORTER SHAFT
29	416158001	ARM SHAFT BALANCE PIN
30	416152201	SET WASHER
31	416524801	MOTOR DRIVE BELT (156XXL)
32	270 R10403000	ARM SHAFT COLLAR
33	416156601	ARM SHAFT CLUTCH ANNULUS SPRING
34	416524901	HAND WHEEL
35	416525001	SET SCREW (M5X10)
36	416525101	HAND WHEEL DECORATED PLATE
#1	270 G4A0535000	FEED CAM COMPLETE
#2	416604601	CRANK CONNECTING ROD COMPLETE
#3	416525201	ARM SHAFT WORM COMPLETE
#4	270 E1A2534000	THREAD TAKE UP LEVER COMPLETE

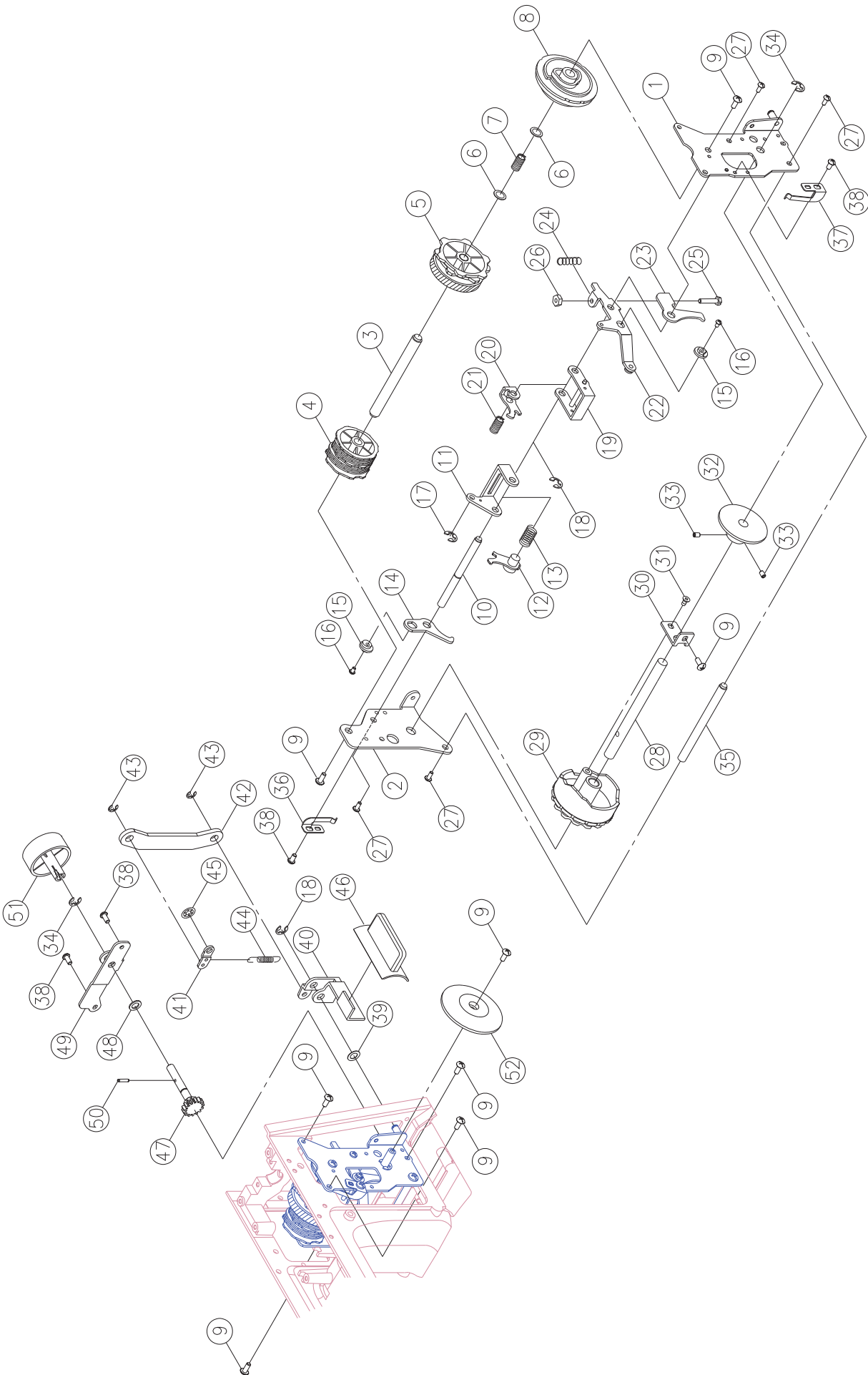

No.	Part No.	Description
1	416525301	PATTERN CAM CONTACT PLATE (FRONT)
2	416525501	PATTERN CAM CONTACT PLATE (BACK)
3	270 V60643003	PATTERN CAM SHAFT
4	270 V60653000	PATTERN CAM
5	270 V60663000	SS CAM
6	270 004300823	WASHER (8.2×12×0.25)
7	270 V60673003	PATTERN CAM SHAFT SPRING
8	270 V60683000	FEED REGULATOR CAM
9	416121501	SET SCREW (M4×8 A)
10	270 V60693000	ZIGZAG CAM CONTACT SUPPORTER SHAFT
11	270 V60703008	ZIGZAG CAM CONTACT SUPPORTER
12	270 V60713003	ZIGZAG CAM CONTACT
13	270 V10693003	ZIGZAG CAM CONTACT SPRING
14	270 V60723003	ZIGZAG REGULATOR PLATE
15	270 V60733000	ZIGZAG REGULATOR NUT
16	270 004230316	SET SCREW (M3×10 B)
17	416116101	E-RING (ETW-4)
18	416116301	E-RING (ETW-5)
19	270 V60743003	SS CAM CONTACT SUPPORTER
20	270 V60763003	SS CAM CONTACT
21	416166401	SS CAM CONTACT SPRING
22	270 V60783003	FEED REGULATOR CRANK
23	416166601	BH REGULATOR PLATE
24	270 V60813003	BH SPRING
25	270 004240706	SET SCREW (M4×20)
26	416126801	NUT (ALN-4)
27	416119201	SET SCREW (M3×6 A)
28	416172701	PATTERN SELECTOR CAM SHAFT
29	270 V70053000	PATTERN SELECTOR CAM
30	270 V60853003	PATTERN SELECTOR CAM PLATE
31	270 004240166	SET SCREW (M4×8)
32	270 V60863000	BH PATTERN SELECTOR CAM
33	416122401	SET SCREW (M4×4 C)
34	416116401	E-RING (ETW-6)
35	270 V60823003	PATTERN CAM CONTACT SUPPORTER SHAFT
36	270 V60873003	PATTERN PLATE
37	270 V60883003	FEED REGULATOR
38	416121201	SET SCREW (M4×6 B)
39	270 004300186	WASHER (6.2×12×0.5)
40	416172601	REVERSE LEVER
41	416167601	REVERSE PLATE
42	416167701	REVERSE ROD
43	416116001	E-RING (ETW-3)
44	416155001	SPRING
45	416116801	CS-RING (CSTW-4.5)
46	270 V4B0083209	REVERSE BUTTON
47	416525701	SELECTOR DIAL SHAFT COMPLETE
48	270 004300843	WASHER (7.2×12×1.0)
49	270 V60923003	SELECTOR DIAL PLATE
50	416117301	SPRING PIN (φ2.5×12)
51	416159501	SELECTOR DIAL
52	416525801	PATTERN DISPLAY PULLEY

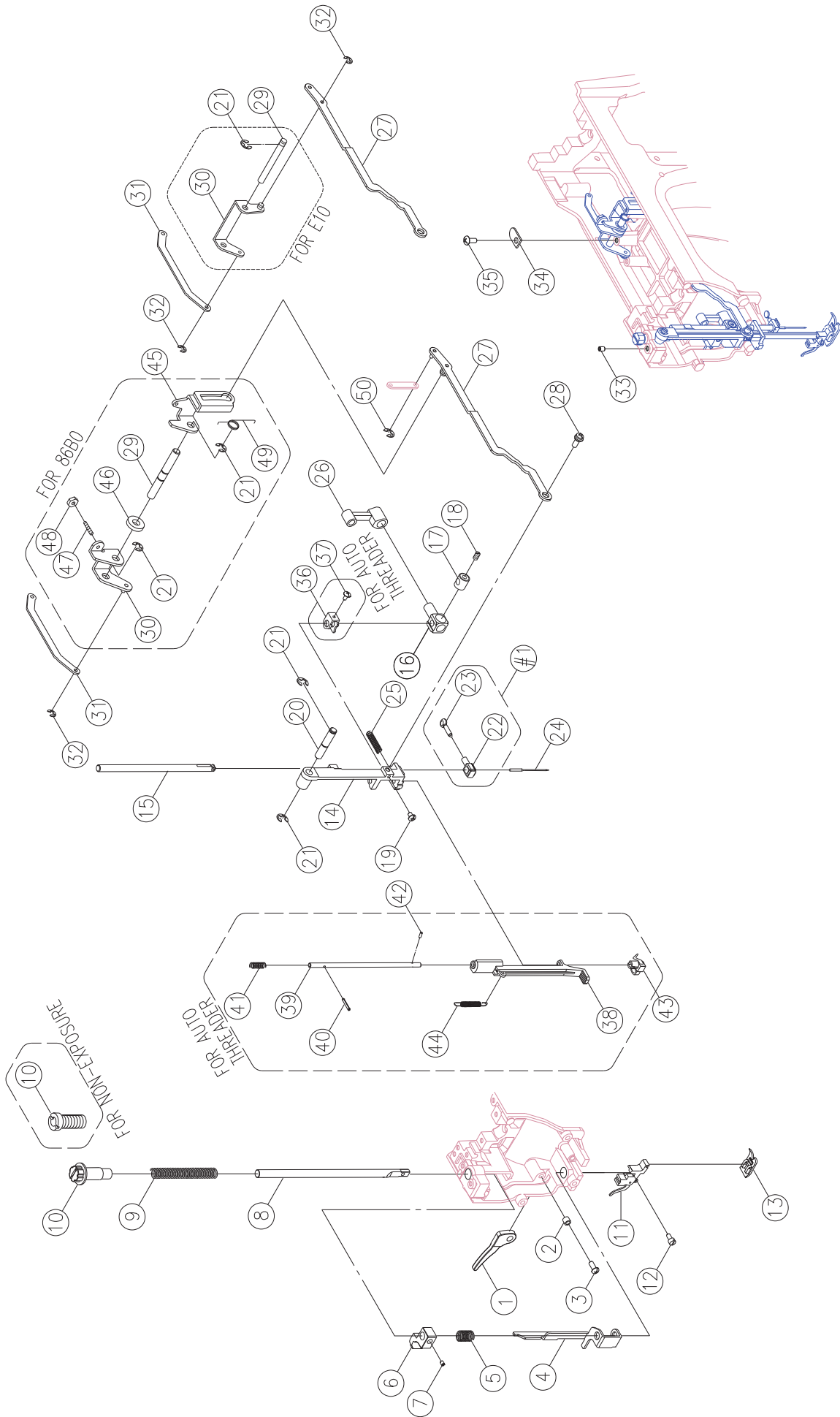

No.	Part No.	Description
1	1 270 V10333000	PRESSER BAR LIFTER LEVER
2	416162101	PRESSER BAR LIFTER LEVER SCREW WASHER
3	416121101	SET SCREW (M4X10 B)
4	416525901	TENSION LEVER LIFTER
5	416151601	TENSION LEVER LIFTER SPRING
6	416151501	PRESSER BAR BRACKET
7	416123801	SET SCREW(M6×5 C)
8	416173401	PRESSER BAR
9	416173501	PRESSER BAR SPRING
10	416171901	PRESSER BAR REGULATING SCREW
11	416128201	SHANK COMPLETE
12	416118401	SHANK SCREW (9/64×40×8)
13	416128401	ALL PURPOSE FOOT (J)
14	270 V61973002	NEEDLE BAR SUPPORTER
15	416173601	NEEDLE BAR
16	416151101	NEEDLE BAR BRACKET (1)
17	416151201	NEEDLE BAR BRACKET (2)
18	416122401	SET SCREW(M4×4 C)
19	270 004106202	SET SCREW(9/64×40×6)
20	270 N80223003	NEEDLE BAR SUPPORTER PIN
21	416116301	E-RING (ETW-5)
22	416157701	NEEDLE CLAMP
23	416245301	NEEDLE CLAMP SCREW
24		NEEDLE
25	416152701	NEEDLE BAR SUPPORTER SPRING
26	416245501	NEEDLE BAR CRANK ROD
27	270 V70023003	NEEDLE BAR DRIVING ROD
28	416408701	NEEDLE BAR DRIVING ROD PIN
29	270 V70103003	ZIGZAG CAM CONTACT SUPPORTER SHAFT
30	270 V70093003	ZIGZAG REGULATOR CRANK
31	270 V61043003	ROD
32	416116101	E-RING (ETW-4)
33	416121001	SET SCREW(M4×5 C)
34	416152201	SET WASHER
35	416121501	SET SCREW(M4×8 A)
#1	416150301	NEEDLE CLAMP COMPLETE

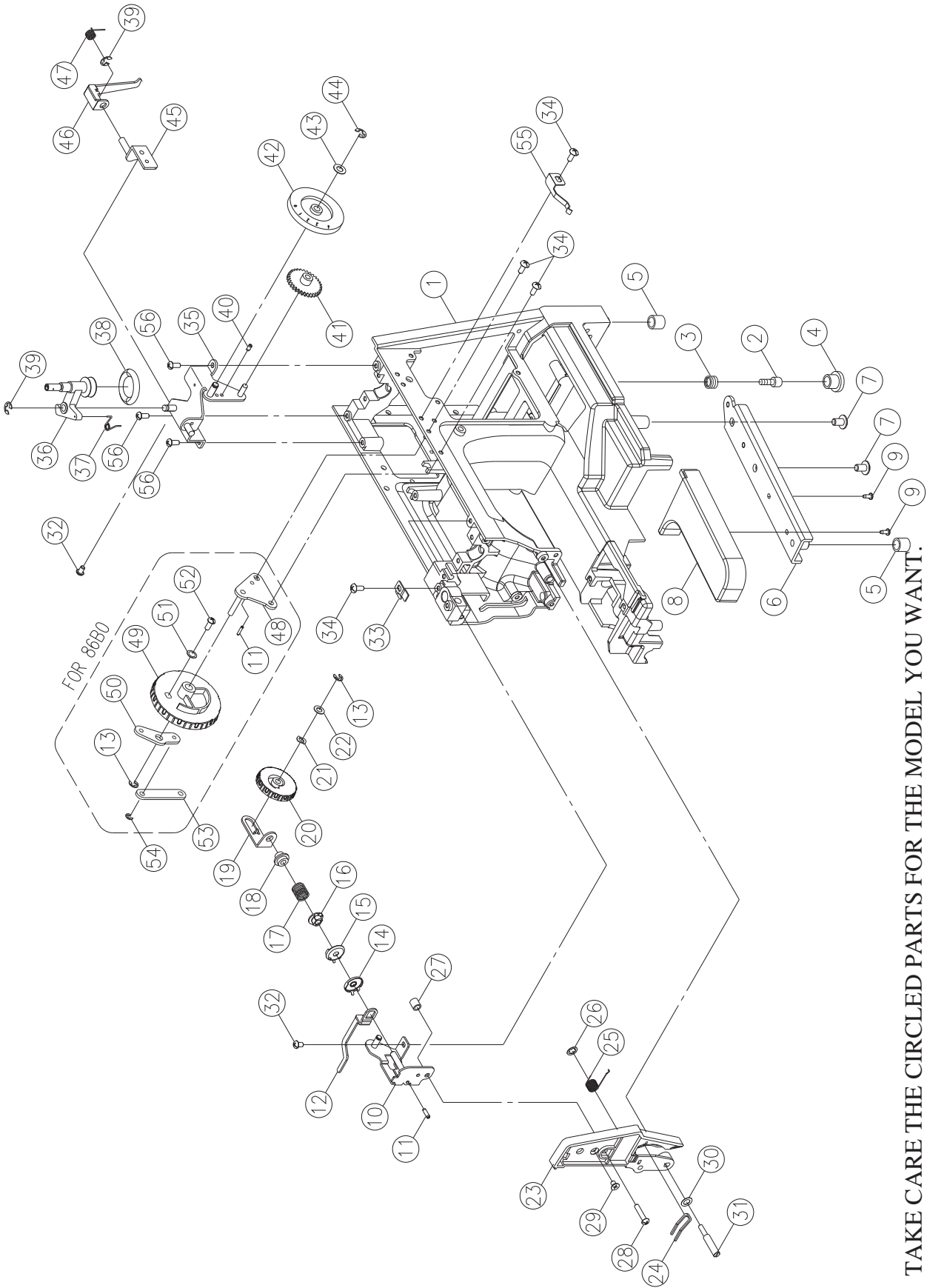

TAKE CARE THE CIRCLED PARTS FOR THE MODEL YOU WANT.

No.	Part No.	Description
1	N/A	ARM
2	416154601	BASE PLATE ADJUSTMENT SCREW
3	416154401	BASE PLATE ADJUSTMENT SCREW SPRING
4	416526001	ADJUSTMENT FREE ARM BASE CUSHION RUBBER
5	416526101	FREE ARM BASE CUSHION RUBBER
6	416526201	FREE ARM FOOT
7	416526301	SET SCREW (M6X10)
8	270 V6E1143210	FREE ARM FOOT BASE
9	416526501	SET SCREW (M3×8)
10	416526601	DIAL TENSION SUPPORTER PLATE
11	416117501	SPRING PIN (φ3×10)
12	416526701	DIAL TENSION WAFT PLATE
13	416116101	E-RING (ETW-4)
14	416153601	DIAL TENSION DISC (1)
15	416146301	DIAL TENSION DISC
16	416526801	DIAL TENSION SPRING REGULATOR
17	416155901	DIAL TENSION SPRING
18	416412101	DIAL TENSION REGULATOR
19	270 V60273006	DIAL TENSION SPRING PLATE
20	416526901	DIAL TENSION KNOB
21	416126001	WASHER (WW-5)
22	416124501	WASHER (5.2×10×0.5)
23	416527001	DIAL TENSION SUPPORTER PLATE COVER
24	416171301	THREAD GUIDE
25	270 V60303000	THREAD GUIDE SPRING
26	416116701	CS-RING (CSTW-5)
27	416151701	DIAL TENSION GUIDE SPRING TUBE
28	416527101	SET SCREW (M4×20 B)
29	416121901	SET SCREW (M4×6 D)
30	416124101	WASHER (4.2×8×0.8)
31	270 004240982	SET SCREW (M4×14)
32	416121201	SET SCREW (M4×6 B)
33	416527201	TENSION LEVER REGULATING PLATE
34	416121501	SET SCREW (M4×8 A)
35	416527301	BOBBIN WINDER FRAME COMPLETE
36	416169701	BOBBIN WINDER CRANK COMPLETE
37	416171201	BOBBIN WINDER CRANK SPRING
38	416149201	BOBBIN WINDER RUBBER PULLEY
39	416116301	E-RING (ETW-5)
40	270 003043008	SPRING PIN (φ3×8×0.6)
41	416169801	STITCH LENGTH GEAR
42	416527401	STITCH LENGTH DIAL COMPLETE
43	270 004300186	WASHER (6.2×12×0.5)
44	416116201	E-RING (ETW-4)
45	416527501	CLUTCH ROD PLATE CPL
46	416197501	CLUTCH ROD
47	270 P3A1183003	CLUTCH ROD SPRING
56	416121301	SET SCREW (M4×8 B)

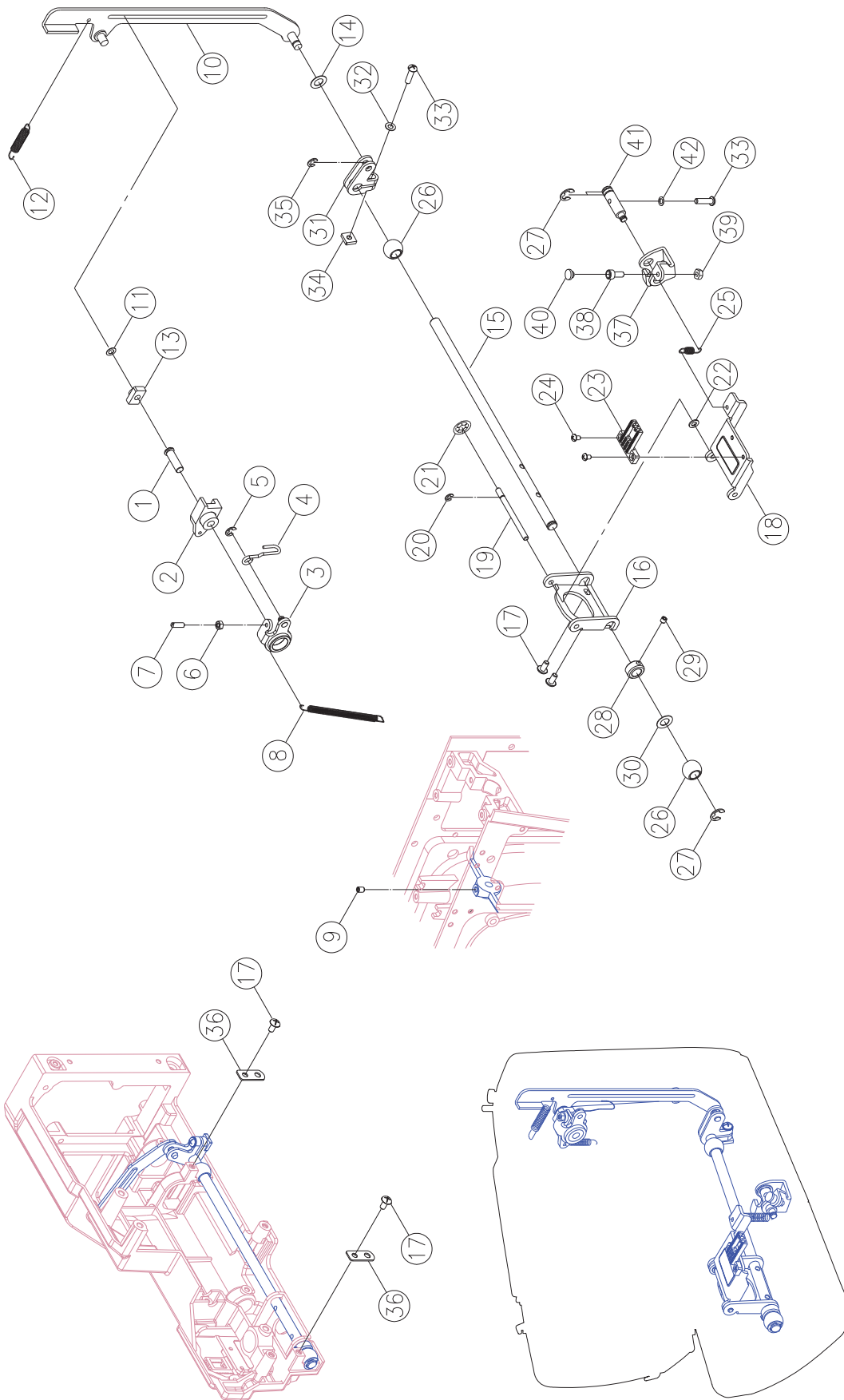

No.	Part No.	Description
1	270 V60443000	FEED REGULATING SHAFT
2	270 V60433000	FEED REGULATING
3	270 V60393003	FEED REGULATING PLATE
4	270 V60423003	FEED ROD
5	416116201	E-RING (ETW-4)
6	416126301	NUT (9/64×40 T=3)
7	270 004106053	SET SCREW (9/64×40×11)
8	270 V70063003	FEED REGULATING SPRING
9	416122101	SET SCREW (M4×6 C)
10	270 V60453003	FORK ROD
11	270 004400180	ENDURE ATTRITION WASHER (5.7×10.2×0.5)
12	270 V60463003	FORK ROD SPRING
13	270 V11533000	FEED REGULATING BLOCK
14	270 004400450	ENDURE ATTRITION WASHER (5.5×12×0.25)
15	270 V60483000	FEED ROCK SHAFT
16	270 V60493003	FEET ROCK FRAME
17	416121501	SET SCREW (M4×8 A)
18	270 V60503003	FEED DOG FRAME
19	270 V60513003	FEED DOG FRAME SHAFT
20	416116001	E-RING (ETW-3)
21	270 003090043	NUT (SPN-4)
22	416124101	WASHER (4.2×8×0.8)
23	416171601	FEET DOG
24	270 004230056	SET SCREW (M3×5 B)
25	270 V60533003	FEED DOG FRAME SPRING
26	270 V60343000	FEED ROCK BUSHING
27	416116401	E-RING (ETW-6)
28	270 G2D0335000	PATTERN CAM SHAFT COLLAR
29	416122401	SET SCREW (M4×4 C)
30	270 004400410	ENDURE ATTRITION WASHER (8.2×12×0.25)
31	270 V60553003	FEED ROCK CRANK
32	270 004300093	WASHER (4×8×0.5)
33	416121701	SET SCREW (M4×15 B)
34	270 004840073	FEED ROCK CRANK NUT (M4)
35	416116101	E-RING (ETW-4)
36	270 V60563003	BUSHING HOLDER PLATE
37	270 V60583003	FEED LIFTING ROCK CRANK
38	270 004250323	SEW SCREW
39	270 004840022	NUT (M4 T=3)
40	270 K81243000	SEW SCREW KNOB
41	270 V60593003	FEED LIFTING ROCK SHAFT
42	270 004600026	WASHER (4.2×7.2×1.2)

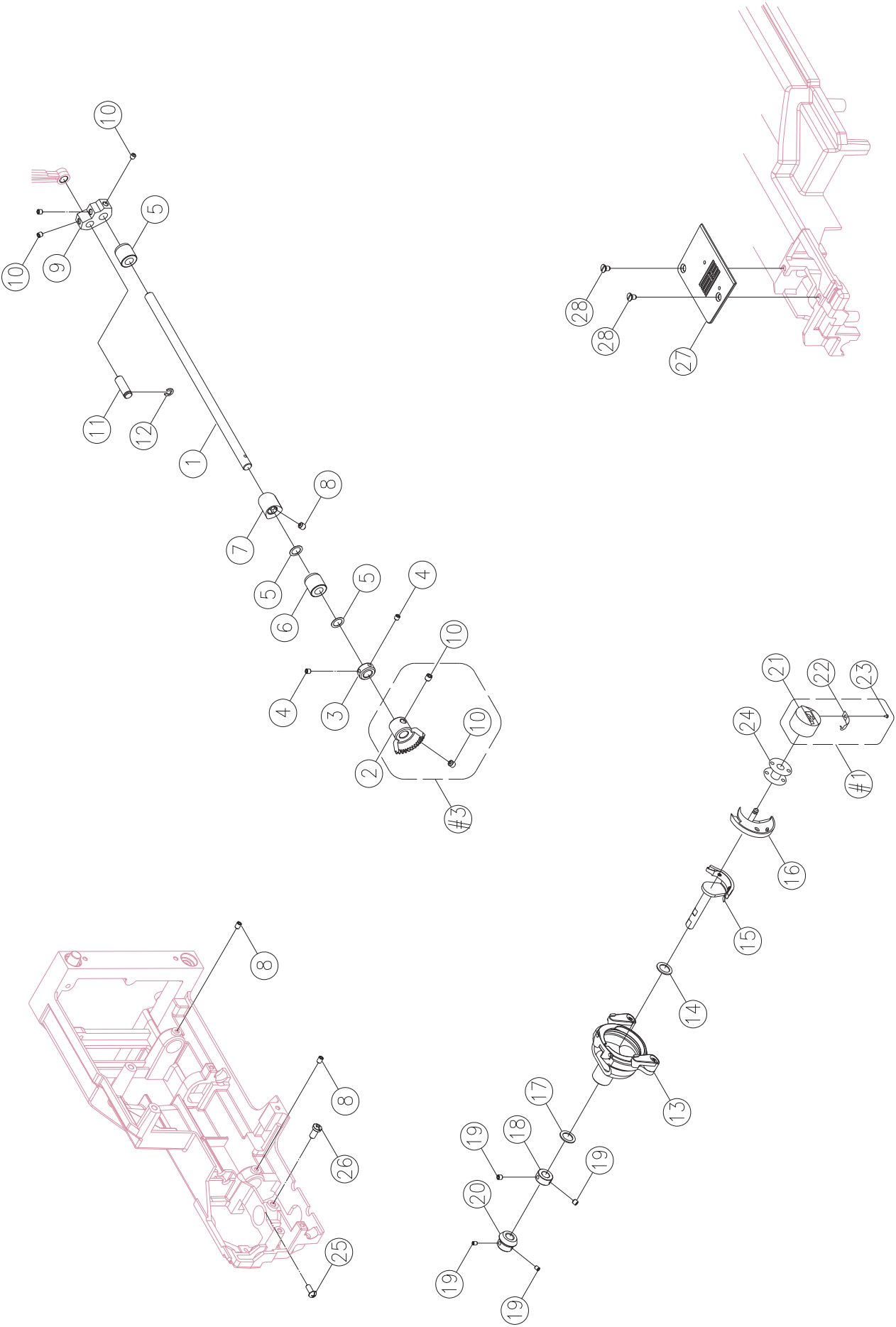

No.	Part No.	Description
1	416527801	LOWER SHAFT
2	270 G4A1573000	LOWER SHAFT GEAR
3	416520801	LOWER SHAFT COLLAR
4	416122401	SET SCREW (M4X4C)
5	270 004400410	ENDURE ATTRITION WASHER (8.2X12X0.25)
6	416141701	FEED ROCK BUSHING
7	416520701	FEED LIFTING ROCK CAM
8	416122101	SET SCREW (M4X6C)
9	416162901	CRANK CONNECTING ROD CRANK
10	270 004250203	SET SCREW (M5X5C)
11	270 V10833003	CRANK CONNECTING ROD CRANK PIN
12	416116301	E-RING (ETW-5)
13	270 V10995000	OPEN SHUTTLE RACE COMPLETE
14	270 004400800	ENDURE ATTRITION WASHER (7.6×12×0.13)
15	270 K81125000	SHUTTLE DRIVER COMPLETE
16	416392101	SHUTTLE HOOK (4.6MM)
17	270 004400210	ENDURE ATTRITION WASHER (8.2×16×0.5)
18	416520901	SHUTTLE DRIVER SHAFT COLLAR
19	270 004107293	SET SCREW(11/64×40×4)
20	416521001	SHUTTLE DRIVER SHAFT GEAR
21	416153501	BOBBIN CASE
22	270 H13803001	BOBBIN CASE SPRING
23	416152601	BOBBIN CASE SPRING SET SCREW
24	416303001	BOBBIN
25	416121101	SET SCREW (M4X10B)
26	270 004250151	SET SCREW (M5X10B)
27	416171501	NEEDLE PLATE
28	416122901	NEEDLE PLATE COMPLETE SET SCREW
#1	416153401	BOBBIN CASE COMPLETE
#2	416245801	LOWER SHAFT GEAR COMPLETE

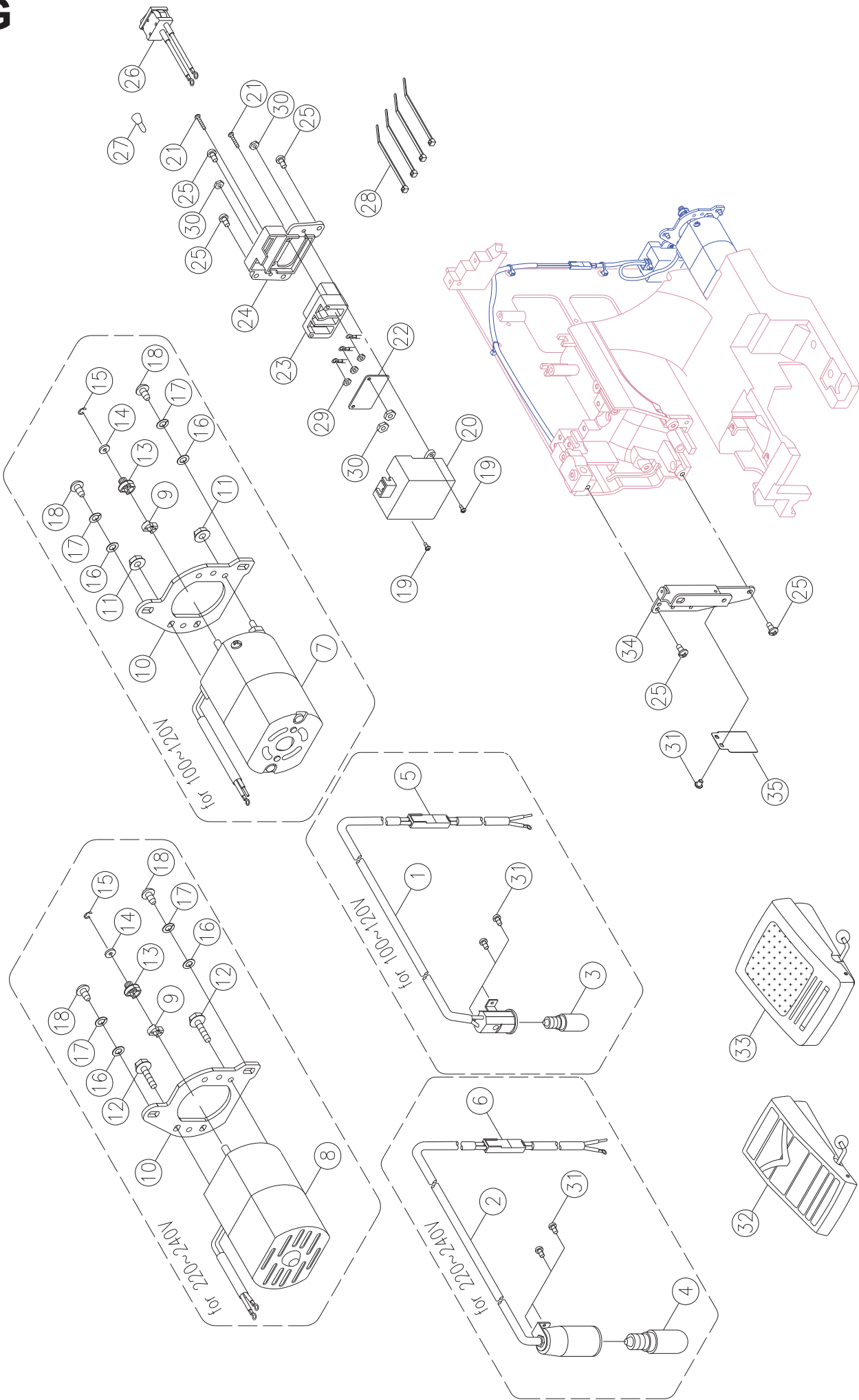

ALL VOLTAGE APPLICATION & SPEC. ,PLEASE CHECK NEXT PAGE.

No.	Part No.	Description	
1	270 002433418	LAMP HOLDER COMPLETE	FOR 100~ 120V
2	270 002423118	LAMP HOLDER COMPLETE	FOR 220~240V
3	416126901	LAMP (10W) FOR 120V	
4	416127001	LAMP (15W) FOR 240V	
5	416115201	LEAD WIRE ASS 'YFOR 100~120V	
6	416114901	LEAD WIRE ASS 'YFOR 220~240V	
7	270 001351109	MOTOR COMPLETE HF-07150	FOR 110~120V /U.S.A
8	416430001	MOTOR COMPLETE HF-07250	FOR 230V /EU.
	416528101	MOTOR COMPLETE HF-07250	FOR 230V / DUBAI
	416528201	MOTOR COMPLETE HF-07250	FOR 230V / INDIA
	270 001V881003	MOTOR COMPLETE HF-07250	FOR 240V /U.K
	270 001V881005	MOTOR COMPLETE HF-07250	FOR 240V /SAA
9	416129401	CUSHION RUBBER	
10	270 002397025	MOTOR BRACKET	
11	270 004840131	NUT (M4 T=5.5)	FOR 100~120V
12	416521501	SET SCREW (M4×10.2)	FOR 220~240V
13	270 002396029	BELT WHEEL	
14	416114001	MOTOR FEED REGULATOR COLLAR	
15	416116001	E-RING (ETW-3)	
16	416124301	WASHER (5.4×10×0.9)	
17	416126201	SPRING WASHER (5.2×9×1)	
18	416224801	SET SCREW (M5×12)	
19	416119701	SET SCREW (M3×8 B)	
20	270 002248129	RECEPTACLE HOLDER COVER	
21	416184901	SET SCREW (M3×20)	
22	416183601	CONCERT INSULATION PLATE	
23	416184701	RECEPTACLE	
24	270 002252129	RECEPTACLE HOLDER	
25	416121501	SET SCREW (M4×8 A)	
26	416115001	SWITCH ASS 'Y	
27	416133001	END TERMED	
28	416113901	CORD CLIP	
29	270 004840120	NUT (M3×4)	
30	416302901	NUT (M3 T=2.3)	
31	416528801	SET SCREW (M3×5 B)	
32	416183301	FOOT CONTROLLER (KD-1902)	FOR 100~120V / U.S.A
33	416183101	FOOT CONTROLLER (KD-2902)	FOR 230V / EU.
	416523901	FOOT CONTROLLER (KD-2902)	FOR 230V / DUBAI
	416112701	FOOT CONTROLLER (KD-2902)	FOR 240V / U.K
	416183701	FOOT CONTROLLER (KD-2902)	FOR 240V / SAA
34	270 V61283006	LAMP BRACKET	
35	270 VG40123000	SHIELD	

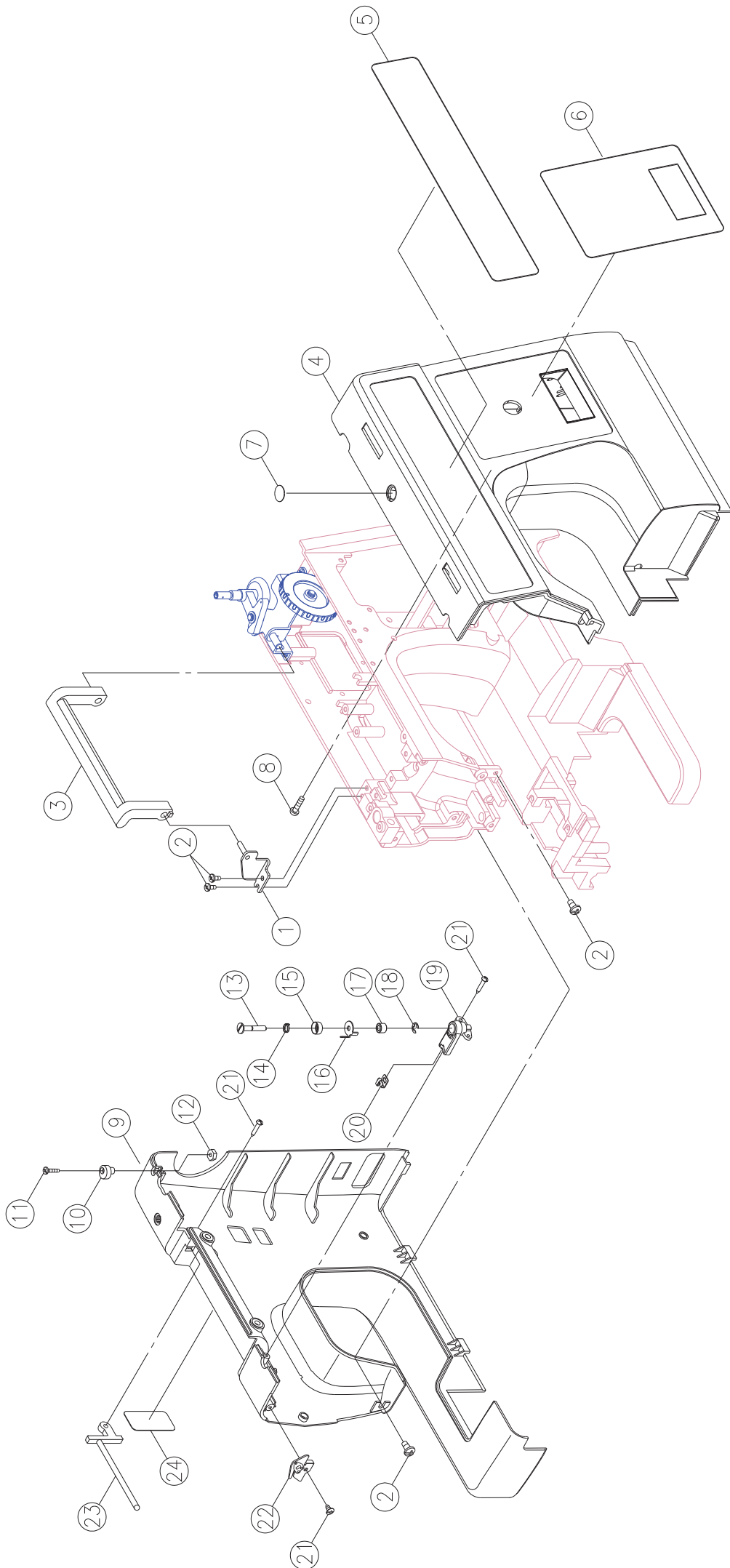

No.	Part No.	Description
1	270 V62033006	HANDLE BRACKET COMPLETE
2	416121501	SET SCREW (M4×8 A)
3	416529001	HANDLE
4	416529101	FRONT COVER CPL
5	416529101	FRONT PANEL
6	416529101	FRONT PANEL
7	270 V61503209	PLATE (1)
8	270 004240526	SET SCREW (M4×12 B)
9	416529401	BACK COVER
10	416146601	BOBBIN WINDER STOPPER
11	416174001	SET SCREW (9/64×40×18 B)
12	416126301	NUT (9/64×40 T=3)
13	416168101	BOBBIN WINDER THREAD GUIDE ADJUSTING SCREW
14	416152401	BOBBIN WINDER THREAD GUIDE SPRING
15	416152301	BOBBIN WINDER SPRING DISC
16	416168201	BOBBIN WINDER THREAD GUIDE
17	416168301	SPACER
18	416116001	E-RING (E-3)
19	416168001	BOBBIN WINDER THREAD GUIDE BASE
20	270 V610363001	THREAD GUIDE
21	270 004230646	SET SCREW (M3×16.7 B)
22	416167801	THREAD GUIDE COMPLETE
23	416169401	SPOOL PIN BASE
24	416529501	PLATE (2)

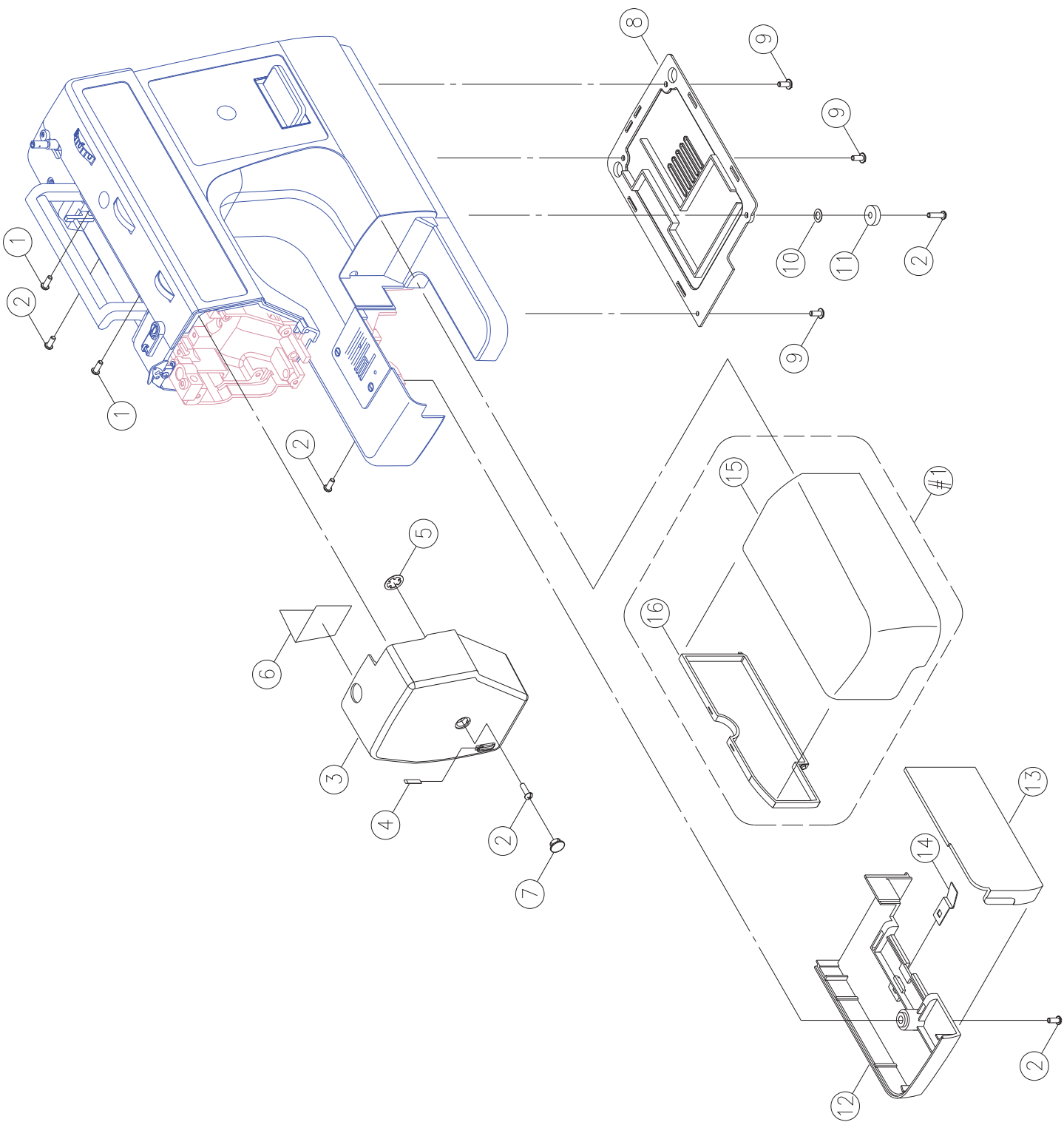

No.	Part No.	Description
1	270 004240186	SET SCREW (M4×15 B)
2	416121101	SET SCREW (M4×10 B)
3	416529701	FACE PLATE COMPLETE
4	416172501	THREAD CUTTER
5	416116701	CS-RING (CSTW-5)
6	270 V61403000	HEAT RESISTANT PLATE
7	416149101	CAP
8	416170501	BOTTOM PLATE
9	416121501	SET SCREW (M4×8 A)
10	416124401	WASHER (5.2×16×1.0)
11	270 J31413000	FREE ARM BASE CUSHION RUBBER
12	416168601	BED COVER
13	416168701	HOOK COVER
14	270 R12453002	HOOK COVER SPRING
15	416529801	SEWING TABLE BODY
16	416529801	SEWING TABLE BODY COVER
#1	416529801	SEWING TABLE BODY COMPLETE

J

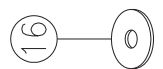
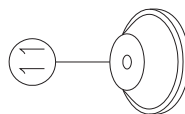
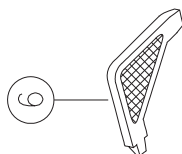
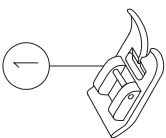
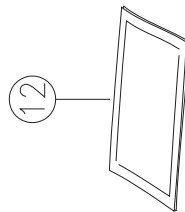
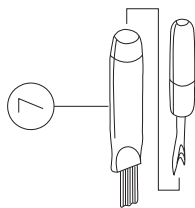
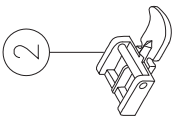
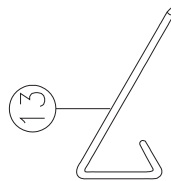
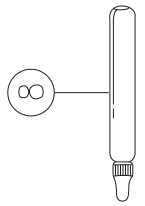
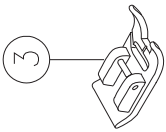
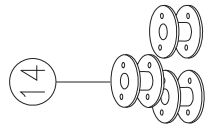
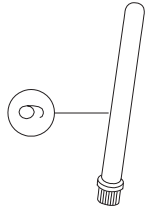
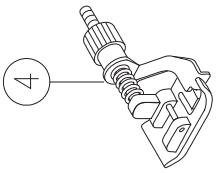
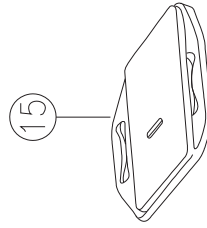
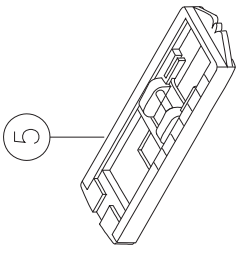

Standard accessories

J

No.	Part No.	Description
1	416128401	ALL PURPOSE FOOT
2	416128701	ZIPPER FOOT (I)
3	270 006804008	SATIN STITCH FOOT
4	416128501	BLIND HEM FOOT (L)
5	416128901	BUTTONHOLE FOOT (B)
6	270 006093009	L-SCREWDRIVER
7	416127701	SEAM RIPPER/ BRUSH
8		OIL BOTTLE
9	416157501	SECOND SPOOL PIN
10	416157601	SPOOL HOLDERS (SMALL)
11	416157101	SPOOL HOLDERS (LARGE)
12		PACK OF NEEDLE
13	416127101	SEAM GUIDE
14	270 006084009	BOBBIN
15	416127901	DARNING PLATE
16	416127301	FELT PAD
17	416530301	SOFTCOVER